



Design, Realization and Measurements of Printed Patch Antenna with Circular Slots for UWB and IoT Applications

Abdelhakim Moutaouakil * 

*Corresponding Author, Modelisation of Complex Systems Laboratory, Cadi Ayyad University, Marrakech, Morocco. E-mail: moutaouakilabdo@gmail.com

Younes Jabrane 

Modelisation of Complex Systems Laboratory, Cadi Ayyad University, Marrakech, Morocco. E-mail: y.jabrane@uca.ma

Abdelati Reha 

Laboratory of Innovation in Management and Engineering for the Enterprise, ISGAM, Morocco. E-mail: Abdelati.reha@isga.ma

Abdelaziz Koumina 

LIRBEM, Cadi Ayyad University, Ecole Normale Supérieure, Marrakech, Morocco. E-mail: Koumina@uca.ac.ma

Abstract

This paper presents the design, simulation and realization of a patch antenna for IOT applications. The patch antenna consists of a radiating element printed on one face of a dielectric substrate, when the ground plane is placed on the other face. In this work, two techniques are used to design a miniaturized patch antenna: the set-up of slots on the radiating element and the use of defective ground plane. Also, the slot's radius and Length of inset point effects on the performances of the antenna is illustrated. All the simulated results are performed with FEKO, a solver based on a Moments Method and measurement is made using Vector Network Analyzer Anritsu MS2026C. The propose antenna resonates in three frequency bands 3.91, 4.86 and 5.16GHz for different characteristics such as radiation pattern, gain, return loss, which makes it suitable for many wireless communication applications such as IoT applications.

Keywords: IoT, Patch Antenna, Slots, UWB, 5G.

Journal of Information Technology Management, 2022, Vol. 14, No.4, pp. 57-68

Published by University of Tehran, Faculty of Management

doi: <https://doi.org/10.22059/jitm.2022.88135>

Article Type: Research Paper

© Authors

Received: April 13, 2022

Received in revised form: May 25, 2022

Accepted: June 28, 2022

Published online: July 13, 2022



Introduction

Many mobile units are growing and attracting more and more users, such as laptops, PDA, mobile phones and IOT applications with Bluetooth and Wi-Fi standards to connect, (Balanis, C. A., 2016) with the Internet of Things, web-enabled devices connect to each other and leverage the data they exchange. The devices communicate via the cloud and connect to the Internet through a Wi-Fi network, a cellular connection (3G or 4G) or Bluetooth. Very soon, 5G will lead us straight into the future: a future of driverless cars, fully connected cities, remote surgery and technological miracles that now seem like something out of a science fiction movie.

The Internet of Things, consists of ordinary devices that can connect to the Internet and communicate with each other via the cloud. This means that it is usually necessary to add special sensors to ordinary objects such as washing machines, heaters, watches and almost anything else. Some devices use these sensors to collect and retransmit information. The very first connected device discussed above, a vending machine, used sensors to monitor its inventory and transmit that information to its owner. Other devices can receive information and then perform an action. For example, smart door locks receive a signal that you want to open them and then perform the operation.

So, the sub-6Ghz spectrum's appeal is as an ideal middle ground between existing network (Barrou, O. et al., 2017). Nowadays, this technologies generalization has become very popular because it offers the connection to Internet services for users at home or in a public place because of its ease of installation, freedom of location and high speed (Consolif, F, et al., 2006). Access to these services from a single terminal requires the use of compact antennas (Darmireddy, N. K., et al., 2015).

The frequencies used by these different applications are spread over the frequency range [1GHz- 5.8GHz] (Gautam, A, et al., 2016). So to get all these devices connected to each other it is necessary to use compact and easy to integrate antennas into the objects. The patch antenna is one of the best solutions used by many engineers because it gives good results in terms of parameters such as directivity, gain, return loss, VSWR (Voltage Standing Wave Ratio), bandwidth, etc (Gupta, N., et al., 2016). In order to improve it further, we need to

make some changes to traditional antennas to make them multi-band and broadband with high performance (Huang, Y., et al., 2008).

According to the literature review, one of these techniques is the set-up of slots on the radiating elements. In this paper, we will study the behavior of a rectangular patch antenna modified with the set-up of circular slots on his radiating element and rectangular slot on his ground plane.

All the results are performed with FEKO, a Solver Based on Moments Method (MoM). The remainder of this paper is organized as follows: the patch antenna geometry is presented in Section II. In Section III, the R and Y effect study is described. Current distributions and radiation patterns are shown in section IV. Experimental results are discussed in Section V. Finally, conclusions are drawn in Section VI.

Theory and design

The concept of patch antenna appeared in 1950, but the real development has been involved in 1970. It can be used alone or as part of a network (Jmes, J. R., et al., 1989). Similarly, it can be integrated closer to the electronic circuits by occupying a reduced volume and conforming to different types of surfaces (Kaur, N. et al., 2017). For the microstrip line shown in Fig. 2 (a), the field lines are inside, and some of them are extended to outer space. For this, an effective dielectric constant (ϵ_{eff}) is introduced to account for fringing and the wave propagation in the line. When an antenna is energized by a microstrip line or other power mode, this generates negative charges around the feed point and positive charges of the other part of the radiator. This charge difference creates electric fields in the antenna; these electric fields are the main cause of the radiation in the printed antenna (Fig 1).

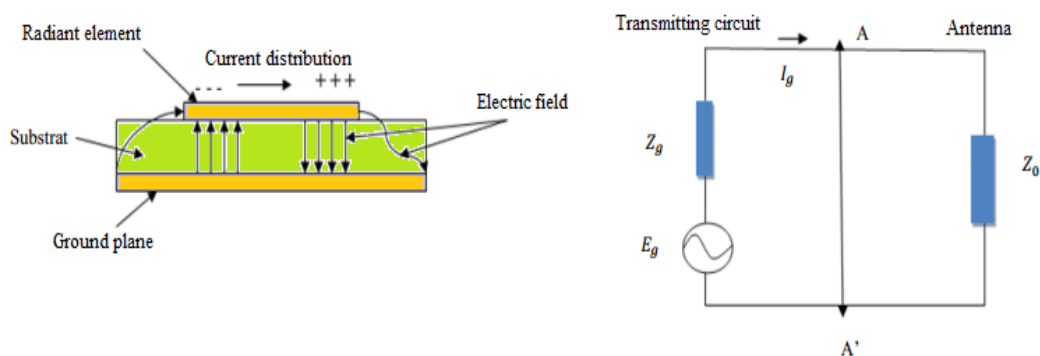

Figure 1. Radiation mechanism and Equivalent diagram of a printed antenna

By applying the theory of transmission lines (Moutaouakil, A., et al., 2022), the printed antenna can be modelled by the electric circuit shown in figure 1 (b). The antenna has a complex input impedance (Moutaouakil, A., et al., 2021) :

$$Z_e = R_e + jX_e \quad (1)$$

The input impedance Z_e , whose reference plane is indicated in Fig. 2, is obtained from E_g , I_e and Z_g the internal impedance of the generator:

$$Z_e = \frac{E_g}{I_e} - Z_g \quad (2)$$

The knowledge of this electrical pattern is crucial to determine how the antenna will convert the incident electrical power into radiated power. In order to optimize the power transfer and to avoid any loss due to mismatch between the electrical source and the antenna, it is necessary to ensure an impedance matching condition. The efficiency of an antenna is the ratio of the radiated power to the total dissipated power. It depends on the ratio between the radiation resistance of the antenna and its losses.

$$\eta = \frac{W_r}{W_a} = \frac{R_{Rad}}{R_{Rad} + R_{Los}} \quad (3)$$

Following is the application we did in order to achieve our patch antenna Fig 2:

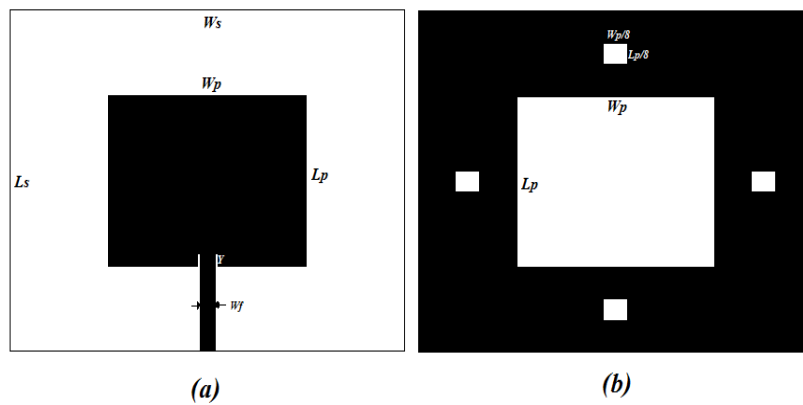

Figure 2. The geometry of a rectangular patch antenna with nick. (a) Top view (b) Bottom view

Several feeding techniques are available such as coaxial feed, proximity coupled feed, microstrip inset feed etc, (Nornikman, H., et al., 2012), (Nornikman, H., et al., 2018), (Orik, N., 2008). to excite the patch. Here, the feed is applied through a microstrip inset feed having the width W_f . The patch antenna is completely designed using FEKO Slover. Here, FR4 epoxy is the substrate as discussed earlier ($\epsilon_r=4.4$), and the parameters characterize our patch antenna (Figure 2) are presented in the following table:

Table 1. Antenna dimensions

Dimension	Value (mm)
Length of substrat L_s	56.02
Width of substrat W_s	72.44
Length of patch L_p	28.01
Width of patch W_p	36.22
Thickness of the substrat h	1.6
Width of supply line W_f	2.8
Length of inset point y	2

However, the most critical limitation of a patch antenna is. Its narrow bandwidth intrinsically linked to its resonant nature, and for improving the bandwidth of a patch antenna, there are several techniques like thickening the substrate, decreasing the dielectric constant or using slits, this last technique (using slits) is our technique that we use to improve our patch antenna (Patnaik, S., 2016), (Rahayu, Y., 2008).

The previous rectangular patch antenna (figure 2) will be modified based on the addition of a circular slot. The Radius of the circular slot is $R = 2$ mm after optimization which is detailed in the next section.

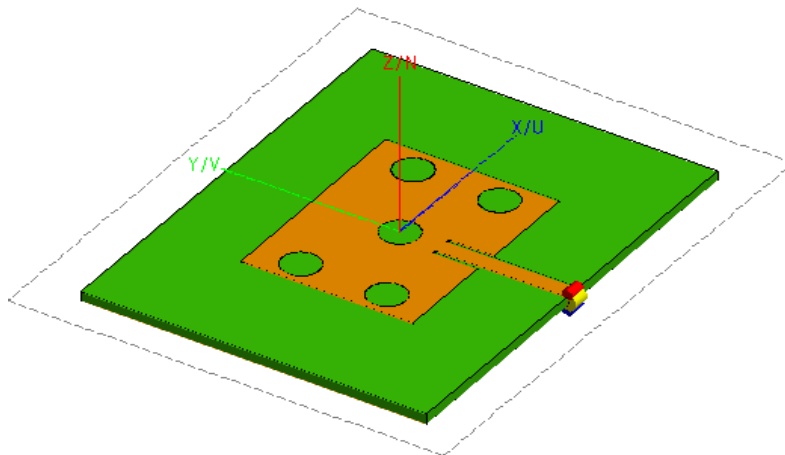

Figure 3. The geometry of the modified antenna 3D view

The simulated S_{11} shows that by adding a circular slot to the rectangular patch antenna show that the antenna resonates in several frequencies (Fig. 4), and the bandwidth of the second band increases.

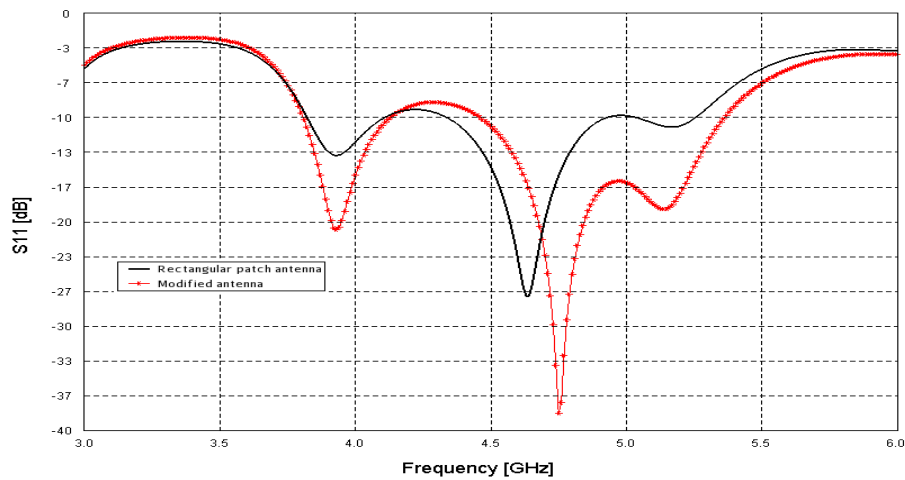

Figure 4. Reflection coefficient S_{11} of the rectangular patch antenna and the modified antenna, as a function of frequency

Figure 4 shows the variation of the reflection coefficient S_{11} at the input of the modified antenna as a function of the frequency in the frequency band [3 GHz -6 GHz], and we note an adaptation of -21 dB of the first band and -38.5dB of the second then -19dB of the third band.

Results and Discussion

R effect study

Figure 5 shows the reflection coefficient S_{11} variation at the input of the modified antenna in terms of the frequency in the band [3 GHz -6GHz], for different radius of the circular slot.

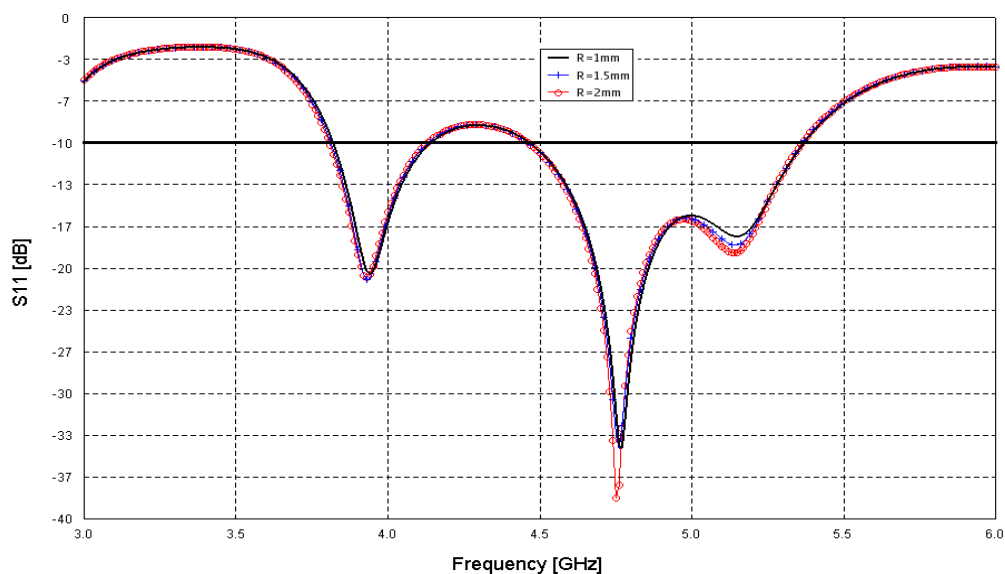

Figure 5. The S_{11} of the modified antenna, as a function of frequency for different radii of the circular slot.

We note that when we increase the radius of the slots the second band becomes very wide (872MHz), which makes it possible to use our antenna for ultra-wide band applications since the band is greater than 500MHz (Reha, A., et al., 2016).

Y effect study

Figure 6 shows the effect of Y on reflection coefficient S11 variation at the input of the modified antenna in terms of the frequency in the band [3 GHz -6GHz]. We note that when Y decreases the second band becomes larger with good adaptation.

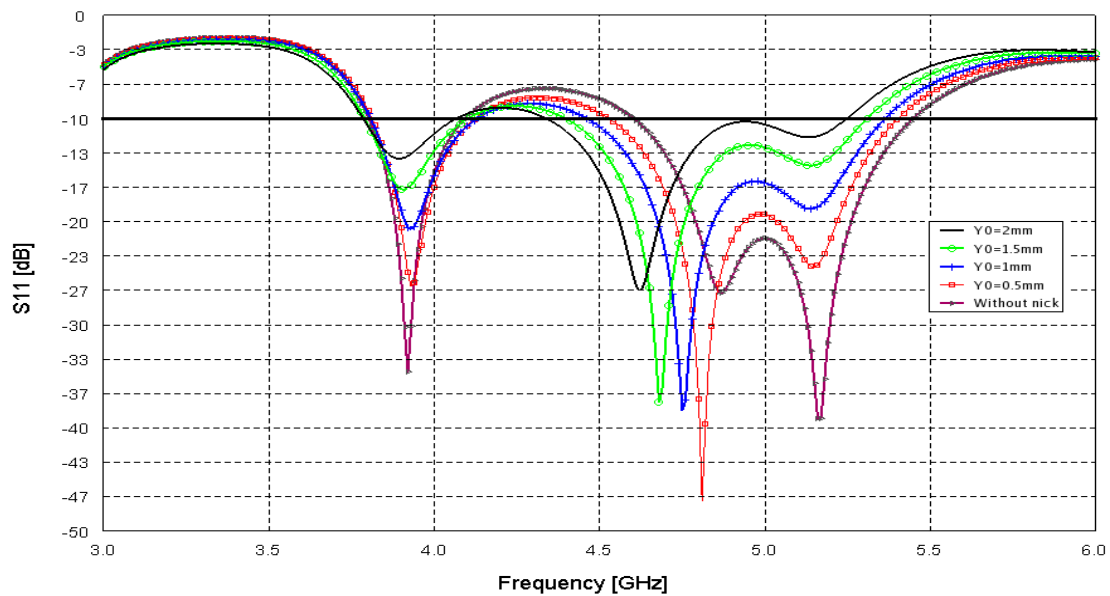

Figure 6. The S11 of the modified antenna, as a function of frequency for different Y

The table below summarizes some results on the antenna performance.

Table 2. Summary results

Antenna	Resonance frequency (GHz)	Bandwidth (MHz) At -10dB	Maximum gain in the resonance frequency (dB)
Y=1mm	3.92	194	4.96
	4.78	701	3.92
	5.14	701	4.21
Y=0.5mm	3.93	313	4.5
	4.81	880	3.51
Y=0mm	5.14	880	4.15
	3.91	286	4.1
	4.86	873	3.2
	5.16	873	3.9

Current distributions and radiation patterns

In order to better understand the antenna behavior, the current distributions at the three-resonance frequency 3.91 GHz, 4.86 GHz, and 4.16 GHz are simulated and shown respectively in figures 7 (a), (b) and (c).

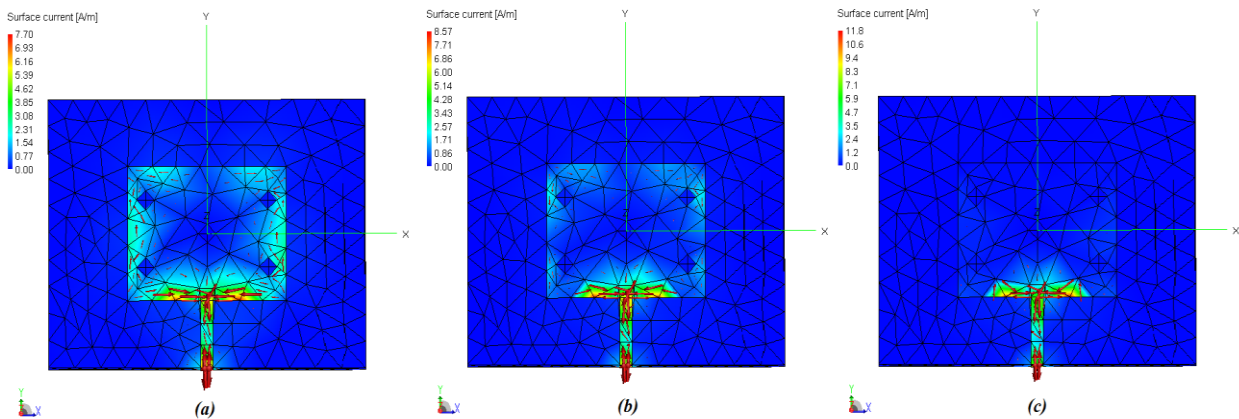

Figure 7. Simulated surface current distributions of the modified antenna

Fig.8 Show the 3D gain for the three resonant frequencies of the modified patch antenna with $R=2\text{mm}$.

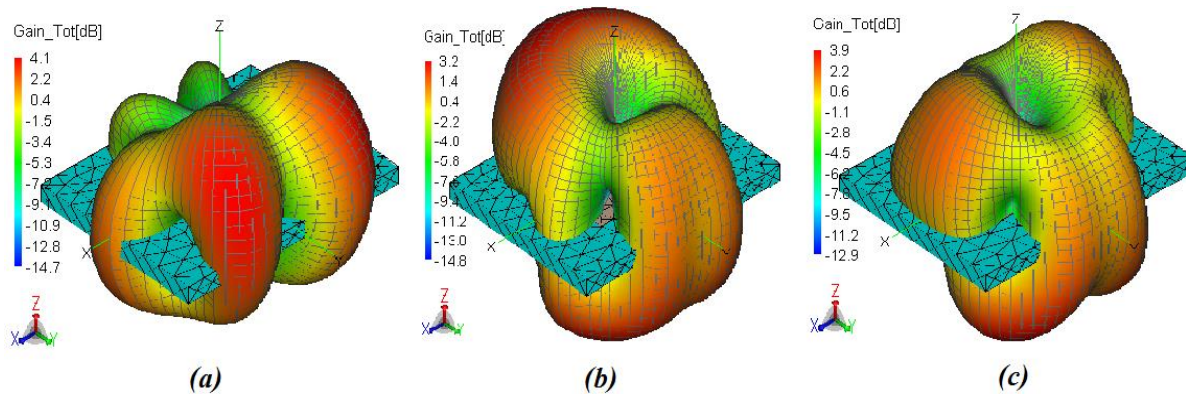

Figure 8. Simulated 3D gain at the three resonant frequencies.

From the 3D gain simulations, we observe that we have a gain of 5.7 dB in the first resonance frequency 1.9 GHz, 6 dB for $F = 3.91$ GHz and 4.86 dB for the third frequency 5.16 GHz.

Fig 9 Show the 2D Electric field for the three resonant frequencies of the modified patch antenna with $R=2\text{mm}$: 3.91GHz, 4.86GHz, 5.16GHz.

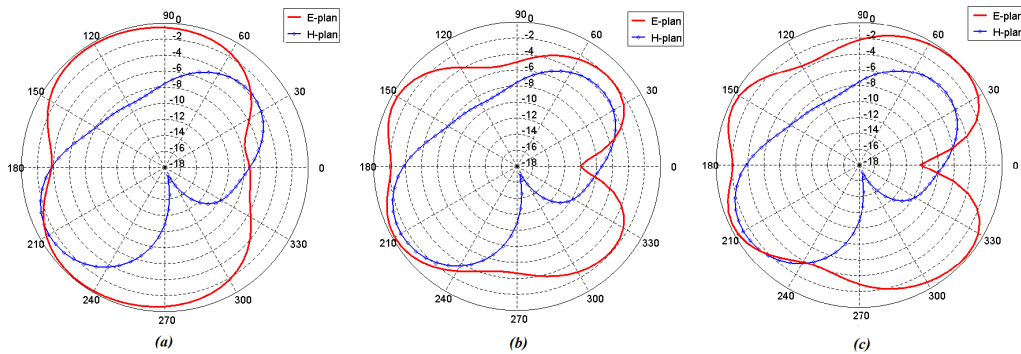

Figure 9. Simulated 2D Electric field at the three resonant frequencies.

The following table represents a comparison between the performances of the antennas found in indexed works and our antenna, we note that our work has an improvement in performances Compared to existing works.

Table 3. Comparison results

References	Dimensions of antenna (mm ³)	Resonance frequency (GHz)	Gain in dB	Applications
(Rooyen, M, et al., 2017)	55×35.5×1.6	2.8/5.8/7.8	1.07/2.53/5.94	S,C,X Band
(Roy, A., et al., 2013)	92.6×62.6×3	3.9/7.4/10.04	6.1/5.9/5.1	S,C,X Band
(Selveraj, D., et al., 2018)	56×50.2×1.6	2.39/2.54	5.035/4.814	WLAN
(Song, S., et al., 2014)	54.36×46.72×1.52	1.86/2.93/3.02/4.50	4.4	S,C Band
(Volakis, J. L., 2007)	50×40×1.6	2.4/5.5	3	S,C Band
Our work	72.44×56.02×1.6	3.91/4.86/5.16	4.1/3.2/3.9	UWB and IOT

Measurement results

The modified antenna is then fabricated and tested using Vector Network Analyzer (VNA Master, Anritsu MS2026C) to validate the simulated results with the experimental results. We confirm with measurements that for the higher frequencies, the bandwidth becomes bigger with good adaptation.

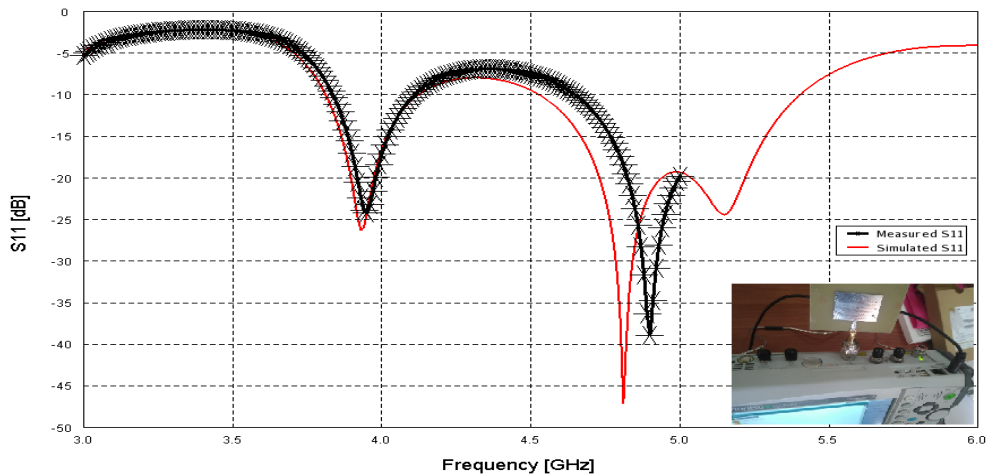

Figure 10. Experimental test set up of antenna

Conclusion

From the simulation work with FEKO, the location of the added circular slots has an effect of improvement on the parameters of the antenna. The modified antenna gain has shown an increase compared to the regular rectangular antenna. The effect of the slot radius is the increase of the bandwidth, resonance in multiple frequencies and also the gain adaptation. The proposed antenna is physically realized. The simple structure, compact size, multi-band frequency, good radiation characteristics, and excellent gain make this antenna suitable for the UWB and IoT applications.

In the future works, the antenna design can be improved by adding the N-number circular slot or define the other new slot into the microstrip patch design, also we can study the effect of the ground plane.

Conflict of interest

The authors declare no potential conflict of interest regarding the publication of this work. In addition, the ethical issues including plagiarism, informed consent, misconduct, data fabrication and, or falsification, double publication and, or submission, and redundancy have been completely witnessed by the authors.

Funding

The author(s) received no financial support for the research, authorship, and/or publication of this article

References

- Balanis, C. A. (2016). *Antenna Theory: Analysis and Design*, Hoboken. *New Jersey: John Wiley and Sons*.
- Barrou, O., Elamri, A., Reha, A. (2017). Designe, Realization and Measurements of Microstrip Patch Antenna Using Three Direct Feeding Modes For 2.45ghz Applications, *International Journal of Computer Engineering and Informtion Technology*, 9(8), 150-156.
- Consolif, F., Maimone, F. and Barbarino, S. (2006). Study of A CPW-FED Circular Slot Antenna for UWB Communications, *Microwave and Optical Technology Letters*, 48(11).
- Darmireddy, N.K., Reddy, R.R. and Prasad, A.M. (2015). Designe of Triple-Layer Double U-Slot Patch Antenna for Wireless applications, *Journal of Applied Research and Technology*, 13(5), 526-534.
- Gautam, A. K., Kumar, L., Kanaujia, B. K., and Rambabu, K., (2016). Design of Compact F-Shaped Slot Triple-Band Antenna for WLAN/WiMAX Applications, *IEEE Transactions on Antennas and Propagation*, 64(3), 1101-1105.
- Gupta, N., Singh, V.K., Ali, Z., and Ahirwa, J. (2016). Stacked Textile Antenna for Multi Band Application Using Foam Substrat, *International Conference on Computational Modeling and Security* , *Procedia Computer Science* 85, 817-877.
- Huang, Y., & Boyle, K. (2008). *Antennas: from theory to practice*, Chichester, UK: *John Wiley and Sons Ltd*.
- Jmes, J.R., & Hall P.S. (1989). *Handbook of Microstrip Antennas*, 1. London, United Kingdom: *IET*.
- Kaur, N., Sharman, N. (2017). Designing of Slotted Microstrip Patch Antenna Using Inset Cut Line Feed For S, C and X Band Applications, *International Journal of Electronics Engineering Research*, 9(7). 957-969.
- Moutaouakil, A., Jabrane, Y., Reha, A., Koumina, A. (2022). Design of Microstrip Sierpinski Carpet Antenna Using a Circular Pattern with Improved Performance. In: *Bennani, S., Lakhrissi, Y., Khaissidi, G., Mansouri, A., Khamlichi, Y. (eds) WITS 2020. Lecture Notes in Electrical Engineering, vol 745. Springer, Singapore.* https://doi.org/10.1007/978-981-33-6893-4_88
- Moutaouakil, A., Jabrane, Y., Reha, A., Koumina, A., El Makoussi, N. (2021). Design and Simulation of a New Dual Band Fractal Antenna for TM Applications. In: *Motahhir, S., Bossoufi, B. (eds) Digital Technologies and Applications. ICDTA 2021. Lecture Notes in Networks and Systems, vol 211. Springer, Cham.* https://doi.org/10.1007/978-3-030-73882-2_94
- Nornikman, H., Ahmad, B. H., Abdul, M. Z. A., Malek, F., Imran, H. and Othman, A. R. (2012). Study and Simulation of Edge Couple Split Ring Resonator (EC-SRR) On Truncated Pyramidal Microwave Absorber, *Progress in Electromagnetics Research (PIER)*, 127, 319-334.
- Nornikman, H., Ahmed, B.H., Abd Aziz, M.Z.A., Bakar, H. A. (2018). Dual Frequencies Band and Enhanced Wideband Effect of Dual Layer Microstrip Patch Antenna with Parasitic, *International Postgraduate Conference on Applied Science & Physics*.

- Oriak, N. (2008). The Challenges and Opportunities of Wireless Technologies in The Classroom: Related Standards and Regulations, *College Teaching Methods & Styles Journal*, 4(4).
- Patnaik, S. (2016). Optimization of Z shaped Microstrip Antenna with I slot Using Discrete Particle Swarm Optimization Algorithm, (*ICCC-2016*), doi: 101016/j.procs,
- Rahayu, Y., Abd rahman, T., Ngah, R., Hall P.S. (2008). Ultra-wideband technology and its applications, *International Conference on Wireless and Optical Communications Networks (WOCN '08)*.
- Reha, A., Elamri, A., Benhmammouch, O., Ould Said, A., El Oquadih, A. and Bouchourbat, M. (2016). CPW-fed slotted CANTOR Set fractal antenna for WiMAX and WLAN applications, *International Journal of Microwave and Wireless Technologies*, 1-7.
- Rooyen, M., Odenaal, J. W. and Joubert. (2017). Hight-gain Directional Antenna for WLAN and WiMAX Applications, *IEEE Antenna and Wireless Propagation Letters*, 16, 286-289.
- Roy, A. A., Mom, J.M., Igwue, G.A., (2013). Enhancing the Bandwidth of a Microstrip Patch Antenna using Slots Shaped Patch, *American Journal of Engineering Research (AJER)*, vol. 2, 23-30.
- Selvaraj, D., Arulkumar, D., Dhinakaran, D. (2018). Radiation Pattern Reconfigurable Antenna for WBAN and WLAN Applications, *International Journal of Scientific Research in Science and Technology*, 4, 727-730.
- Song, S., & Issac, B. (2014). Analysis of WIFI and WIMAX and Wireless Network Coexistence, *International Journal of Computer Networks and Communications*, 6(6)
- Volakis, J.L. (2007). Ed, Antenna engineering handbook. 4th ed, *New York: McGraw-Hill*.

Bibliographic information of this paper for citing:

Moutaouakil, Abdelhakim; Jabrane, Younes; Reha, Abdelati & Koumina, Abdelaziz (2022). Design, Realization and Measurements of Printed Patch Antenna with Circular Slots for UWB and IoT Applications. *Journal of Information Technology Management*, 14 (4), 57-68. <https://doi.org/10.22059/jitm.2022.88135>
